

Serial No.	H-V034-E-13
------------	-------------

Sediment strainer (Type Y)

User 's Manual





Contents (page)



- (1) Be sure to read the following warranty clauses of our product 1
- (2) General operating instructions 2
- (3) General instructions for transportation, unpacking and storage 2
- (4) Name of parts 3
- (5) Maximum working pressure vs. temperature 4
- (6) Installation procedure 5
 - Flanged end type 6
 - Threaded end type 7
 - Socket end type 8
- (7) Cleaning and replacing method for screen 9
- (8) Inspection items 9
- (9) Troubleshooting 9
- (10) Handling of residual and waste materials 9

This user's guide contains very important information for the proper installation, maintenance and safe use of an ASAHI AV Product. Please store this manual in an easily accessible location.

<Warning & Caution Signs>

 Warning	<p>This symbol reminds the user to take caution due to the potential for serious injury or death.</p>
 Caution	<p>This symbol reminds the user to take caution due to the potential for damage to the valve if used in such a manner.</p>

<Prohibited & Mandatory Action Signs>

	<p>Prohibited: When operating the valve, this symbol indicates an action that should not be taken.</p>
	<p>Mandatory action: When operating the valve, this symbol indicates mandatory actions that must be adhered to.</p>

(1) Be sure to read the following warranty clauses of our product

- Always observe the specifications of and the precautions and instructions on using our product.
- We always strive to improve product quality and reliability, but cannot guarantee perfection. Therefore, should you intend to use this product with any equipment or machinery that may pose the risk of serious or even fatal injury, or property damage, ensure an appropriate safety design or take other measures with sufficient consideration given to possible problems. We shall assume no responsibility for any inconvenience stemming from any action on your part without our written consent in the form of specifications or other documented approval.
- The related technical documents, operation manuals, and other documentation prescribe precautions on selecting, constructing, installing, operating, maintaining, and servicing our products. For details, consult with our nearest distributor or agent.
- Our product warranty extends for one and a half years after the product is shipped from our factory or one year after the product is installed, whichever comes first. Any product abnormality that occurs during the warranty period or which is reported to us will be investigated immediately to identify its cause. Should our product be deemed defective, we shall assume the responsibility to repair or replace it free of charge.
- Any repair or replacement needed after the warranty period ends shall be charged to the customer.
- The warranty does not cover the following cases:
 - (1) Using our product under any condition not covered by our defined scope of warranty.
 - (2) Failure to observe our defined precautions or instructions regarding the construction, installation, handling, maintenance, or servicing of our product.
 - (3) Any inconvenience caused by any product other than ours.
 - (4) Remodeling or otherwise modifying our product by anyone other than us.
 - (5) Using any part of our product for anything other than the intended use of the product.
 - (6) Any abnormality that occurs due to a natural disaster, accident, or other incident not stemming from something inside our product.
- * Note that damage induced by a defect of our product is not covered by warranty.
- This guarantee applies to the use of our product only in Japan. If it is used overseas, please inquire with us separately.

(2) General operating instructions



Warning

- Using a positive-pressure gas with our plastic piping may pose a dangerous condition due to the repellent force particular to compressible fluids even when the gas is under similar pressures used for liquids. Therefore, be sure to take the necessary safety precautions such as covering the piping with protective material. For inquiries, please contact us. For conducting a leak test on newly installed piping, be sure to check for leaks under water pressure. If absolutely necessary to use a gas in testing, please consult your nearest service station beforehand.
- Certain liquid such as H₂O₂, NaClO, etc may be prone to vaporization which may cause irregular pressure increases, which may destroy the valve.
- The flow speed should be less than or equal to the numerical value in the table below. (The screen may be deformed or damaged.)

Nominal size	15-25mm (1/2"-1")	32-50mm (1 1/4"-2")	65, 80mm (1 1/2",3")	100mm (4")
Max. allowable flow speed	5	3	2	1.5



Caution

- Do not step on or apply excessive weight on valve. (It can be damaged.)
- Keep the valve away from excessive heat or fire. (It can be damaged, or destroyed.)
- Always operate the valve within the pressure vs. temperature range. (The valve can be damaged or deformed by operating beyond the allowable range.)
- Allow sufficient space for maintenance and inspection.
- Select a valve material that is compatible with the media. For chemical resistance information, refer to "CHEMICAL RESISTANCE ON ASAHI AV VALVE". (Some chemicals may damage incompatible valve materials.)
- Keep the valve out of direct sunlight, water and dust. Use cover to shield the valve. (The valve will not operate properly.)
- Perform periodic maintenance. (Leakage may develop due to temperature changes or periods of prolonged storage, rest, or operation.)
- The sediment Strainer is so structured as to be vulnerable to repeated stresses due to internal pressure changes in the corner. Damage may therefore occur in a line subject to pulsation. (Including air hammering and water hammering.)
- Install the piping in such a manner that it will not be exposed to direct sunlight. (The body may otherwise get discolored or the screen may get distorted, resulting in failure to function.)

(3) General instructions for transportation, unpacking and storage



Warning

- When suspending and supporting a valve, take care and do not stand under a suspended valve.



Caution

- This valve is not designed to handle impacts of any kind. Avoid throwing or dropping the valve.
- Avoid scratching the valve with any sharp object.
- Do not over-stack cardboard shipping boxes. Excessively stacked packages may collapse.
- Avoid contact with any coal tar creosote, insecticides, vermicides or paint. (These chemicals may cause damage to the valve.)



- Store products in their corrugated cardboard boxes. Avoid exposing products to direct sunlight, and store them indoors (at room temperature). Also avoid storing products in areas with excessive temperatures. (Corrugated cardboard packages become weaker as they become wet with water or other liquid. Take care in storage and handling.)
- After unpacking the products, check that they are defect-free and meet the specifications.

(4) Name of parts

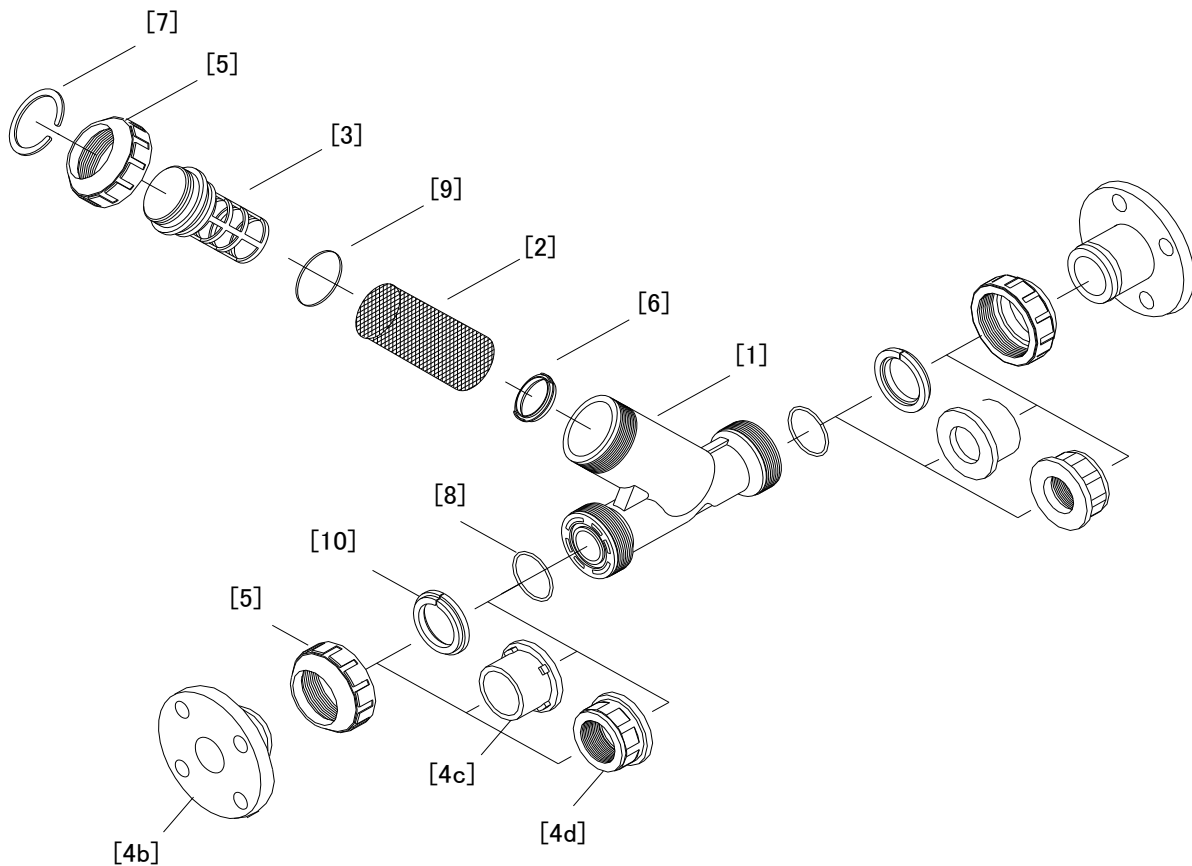

No.	DESCRIPTION	No.	DESCRIPTION
[1]	Body	[5]	Union nut
[2]	Filter screen	[6]	Retaining ring
[3]	Screen support	[7]	Split ring
[4b]	End connector (Flanged end type)	[8]	O-ring(A)
[4c]	End connector (Socket end type)	[9]	O-ring(B)
[4d]	End connector (Threaded end type)	[10]	Stop ring

(5) Maximum working pressure vs. temperature

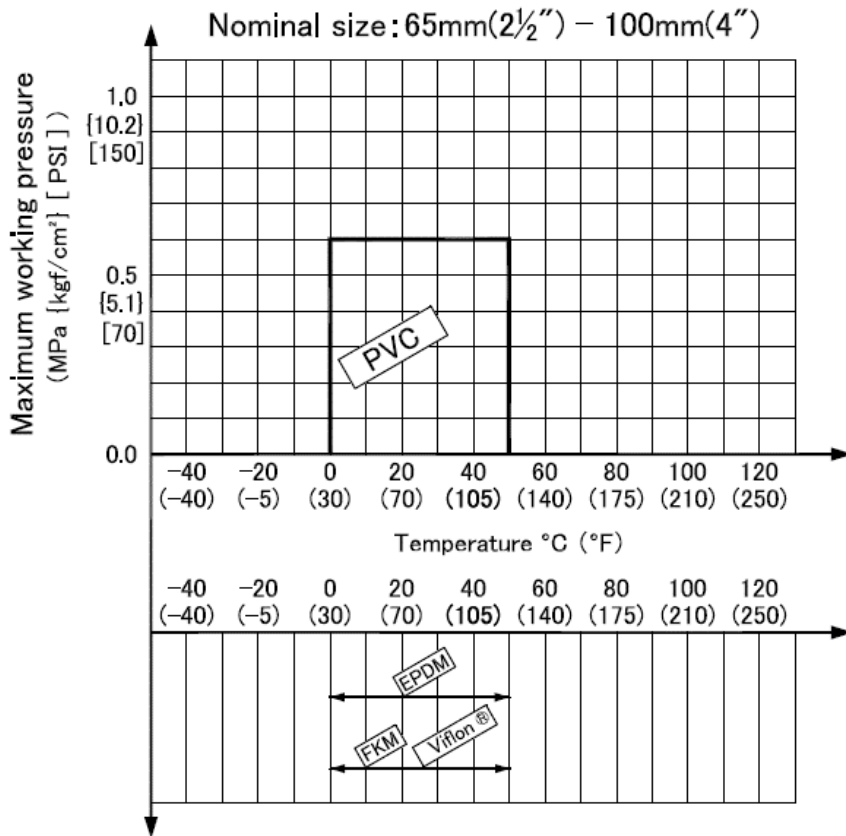
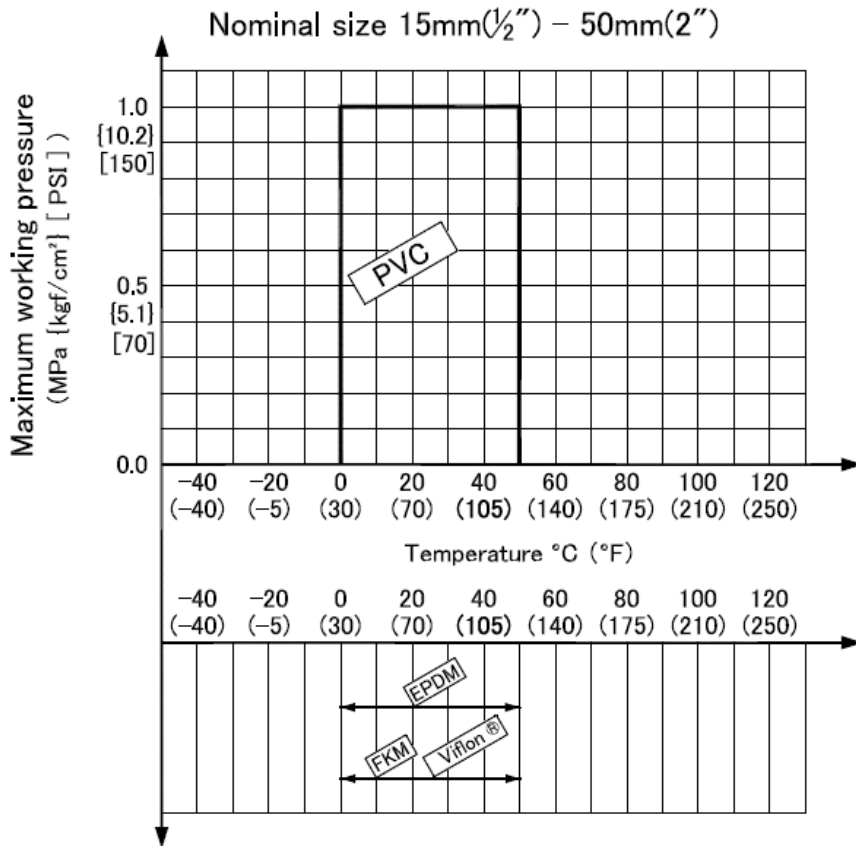

(6) Installation procedure



Warning

- Be sure to conduct a safety check on all hand and power tools to be used before beginning work.
- Wear protective gloves and safety goggles as fluid remain in the valve even if the pipeline is empty. (You may be injured.)



Caution

- When installing a pipe support by means of a U-band or something similar, take care not to over-tighten. (Excessive force may damage the pipe.)
- Take care not to over-tightening the Union Nut. (The valve can be damaged.)
- Do not use the pipe wrench. (The valve can be damaged.)
- When installing pipes and valves, ensure that they are not subjected to tension, compression, bending, impact, or other excessive stress.
- Plumb in the strainer considering the fluid direction (the arrow is shown on the body) so that the screen points downward.

Level installation

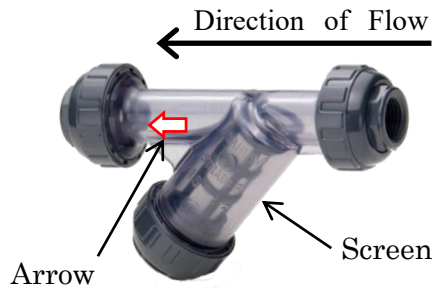

Perpendicular installation

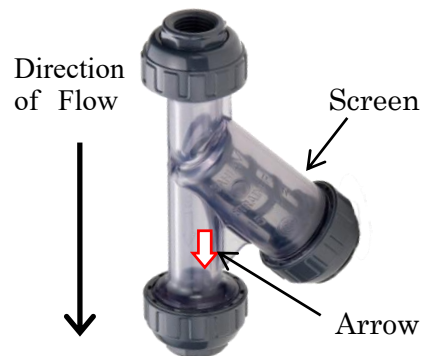

- Install the piping in such a manner that it will not be exposed to direct sunlight. (The body may otherwise get discolored or the screen may get distorted, resulting in failure to function.)
- When installing, disassembling, or reassembling the piping, fix the End Connector.
- Before a water test, be sure that the Union Nut is tightly fastened.
- Fasten the Union Nut while avoiding the parallelism and axial misalignment of the flange surface.
- When connecting a ASAHI AV Valve to metal piping, take care not to let the pipe stress on the ASAHI AV Valve.

Flanged type



- Use flat faced flanges for connection to AV Valves.
- Ensure that the mating flanges are of the same standards.
- Be sure to use sealing gaskets (AV Gasket), bolts, nuts, and washers and tighten them to specified torques.
(When a non-AV gasket is used, a different tightening torque specification should be followed.)

Necessary items

- Torque wrench
- Spanner wrench
- Bolt, Nut, Washer
- AV gasket
- Strap wrench

Procedure

- 1) Set the AV gasket between the flanges.
- 2) Insert washers and bolts from the pipe side, insert washers and nuts from the valve side, then temporarily tighten them by hand.



- The parallelism and axial misalignment of the flange surface should be under the values shown in the following table to prevent damage the valve.
(A failure to observe them can cause destruction due to stress application to the pipe)

Nom. Size	Unit: mm (inch)	
	Axial Misalignment	Parallelism (a-b)
15-32mm (1/2"-1 1/4")	1.0 (0.04)	0.5 (0.02)
40-80mm (1 1/2"-3")	1.0 (0.04)	0.8 (0.03)
100mm (4")	1.0 (0.04)	1.0 (0.04)

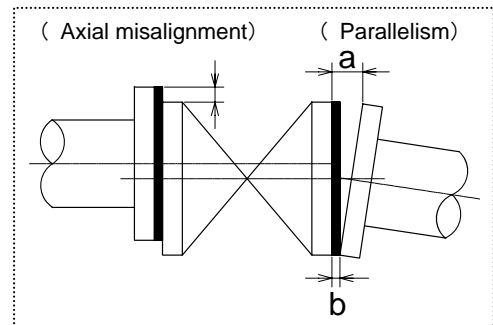

- 3) Using a torque wrench, tighten the bolts and nuts gradually to the specified torque in a diagonal manner. (Refer to fig.1.)
- 4) Tighten it more than 2 turns clockwise with specified torque. (Refer to fig.1.)



- Do not tighten above the specified torque value.
(The valve can be damaged or leaks.)

Recommended torque value

Nom. size	Unit: N·m {kgf·cm} [lb·inch]				
	15mm (1/2")	20mm (3/4")	25-40mm (1"-1 1/2")	50, 65mm (2", 2 1/2")	80-100 mm (3"-4")
PTFE coated	17.5	17.5	20.0	22.5	30.0
PVDF coated	{179} [155]	{179} [155]	{204} [177]	{230} [230]	{306} [266]
Rubber	8.0 {82} [71]	20.0 {204} [177]	20.0 {204} [177]	22.5 {230} [230]	30.0 {306} [266]

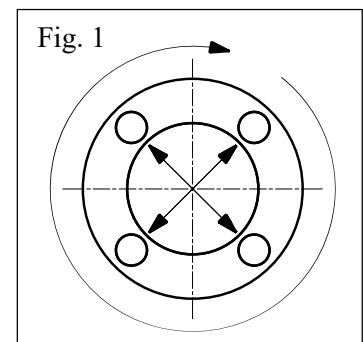



*Be sure to set the union nut [5] when it was removed or loosen from body [1].

- 1) The O-ring (A) [8] should be set on surface of the end connector [4a].
- 2) The end connector [4a] must be put onto the carrier, then ensure that the o-ring (A) [8] is being between the end connector [4a] and the carrier.
- 3) Tighten the union nut [5] hardly with hand.
- 4) Screw the union nut [5] on the body [1] by quarter or half turn using a strap wrench without damaging it.

Threaded type

 - Avoid excessive tightening. (The valve can be damaged.)
Caution

 - Make sure that the threaded connections are plastic. (Metallic threaded can cause damage.)

 - Wrap the threaded joints on our plastic piping with sealing tape. Using a liquid sealing agent or liquid gasket may cause stress cracks (Environmental Stress Cracking). Our product warranty shall not apply in case of said use, even when said use is unavoidable.

Necessary items

● Sealing tape





● Strap wrench

● Spanner wrench

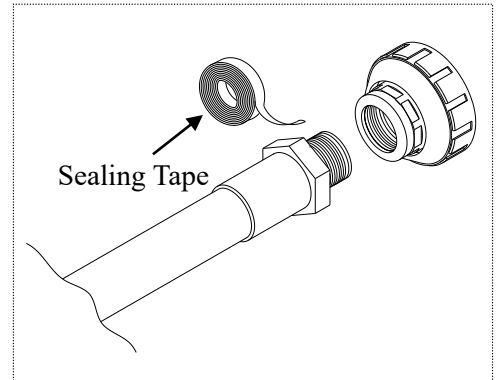
Procedure

- 1) Wind a sealing tape around the external thread of joint, leaving the end (about 3mm [0.12inch]) free.
- 2) Loosen the union nut [5] with a strap wrench.
- 3) Remove the union nut [5] and the end connector [4c].
- 4) Tighten the external thread of the joint and the end connector [4c] hardly with hand.
- 5) Using a spanner wrench, screw the end connector [4c] by turning 180° -360° carefully without damaging it.
- 6) Make sure that the O-ring (A) [8] is mounted.
- 7) Set the end connector [4c] and union nut [5] directly on the body without allowing the O-ring (A) [8] to come off.
- 8) Tighten the union nut [5] hardly with hand.
- 9) Using a strap wrench, screw it in by turning 90° -180° carefully without damaging it.



- Warning**  - When using an adhesive, ventilate the space sufficiently, prohibit the use of a fire in the vicinity, and do not inhale adhesive vapors directly.
-  - If an adhesive gets into contact with your skin, wash it off immediately. If you feel sick or find any anomaly, receive a physician's diagnosis and take appropriate measures promptly.
- Caution**  - Take care in doing work at low temperatures. Solvent vapors are hard to evaporate and are likely to remain. (Solvent cracks may occur, damaging the equipment.)
- After assembling the piping system, open both ends of the piping and use a fan (of the Low-Voltage Type) or something similar to ventilate the space, thus removing the solvent vapors.
-  - Use the appropriate Asahi AV cement.
- Conduct a water test at least 24 hours after joining the pipes with an adhesive.

Necessary items

- Asahi AV cement
- Strap wrench

Procedure

- 1) Loosen the union nut [5] with a strap wrench.
- 2) Remove the union nut [5] and end connector [4b].
- 3) Lead the union nut [5] through the pipe.
- 4) Clean the hub part of the end connector [4b] by wiping with waste cloth.
- 5) Apply adhesive evenly to the hub part of the end connector [4b] and the pipe spigot.

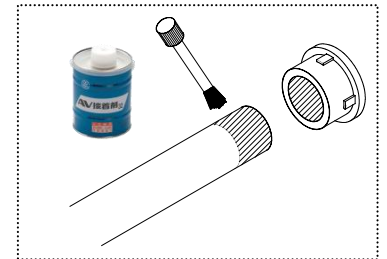

- Caution**  - Do not apply more adhesive than necessary. (The valve can be damaged due to solvent cracking.)





Adhesive quantity (guideline)

Nom. Size	15mm (1/2")	20mm (3/4")	25mm (1")	32mm (1 1/4")	40mm (1 1/2")	50mm (2")	65mm (2 1/2")	80mm (3")	100mm (4")
Quantity(g)	1.0	1.3	2.0	2.4	3.5	4.8	6.9	9.0	13.0



- 6) After applying adhesive, insert the pipe quickly to the end connector [4b] and leave it alone for at least 60 seconds.
- 7) Wipe away overflowing adhesive.
- 8) Make sure that O-ring(A) [8] is mounted
- 9) Set the end connector [4b] and union nut [5] directly on the body without allowing the O-ring (A) [8] to come off.
- 10) Tighten the union nut [5] hardly with hand.
- 11) Using a strap wrench, screw it in by turning 90° -180° carefully without damaging it.

- Caution**  - Do not under any circumstances try to insert a pipe into another fitting or valve by striking it, which may break the piping.

(7) Cleaning and Replacing Method for Screen

- Caution**   - Take care not to over-tighten the Union Nut. (The valve can be damaged.)
 - Do not use the pipe wrench. (The valve can be damaged.)
 - Periodically clean the screen in accordance with the use.

Necessary items

-  Strap wrench
-  Protective gloves
-  Safety goggles



Disassembly and cleaning

- 1) Loosen the union nut [5], and remove the screen part from the body [1]. (Screen part the numbers of the part are [2], [3], [5], [6], [7], and [9].)
- 2) Remove the retaining ring [6], and pull the filter screen [2] out.
- 3) Then wash it to remove the dust or foreign matter, if the filter screen [2] is damaged, replace with a new one.
- 4) Remove the split ring [7] from the screen support [3], and remove the union nut [5].
- 5) Remove the O-ring (B) [9] from the screen support [3], if the O-ring (B) [9] is damaged, replace with a new one.

Reassembly

- 1) Attach the O-ring (B) [9] to the screen support [3].
- 2) Attach the union nut [5] to the screen support [3], and attach the split ring [7].
- 3) Attach the filter screen [2] to the screen support [3], and attach the retaining ring [6].
- 4) Insert the screen part to the body [1], and tighten the union nut [5].

(8) Inspection items

- Caution**   - Perform periodic maintenance. (Leakage may develop due to temperature changes or over periods of prolonged storage, rest or operation.)



○ Inspect the following items.

(1)	Check for any flaw, crack, or deformation on the outside.
(2)	Check whether fluid leaks to the outside.
(3)	Check the tightness of union nuts (loose or not).
(4)	Check the tear, dirt, and deformation of filter screen.

(9) Troubleshooting

Problem	Cause	Treatment
Fluid leaks to the outside.	The union nut is loose.	Retighten.
	The O-ring is scratched or worn.	Replace the O-ring.

(10) Handling of residual and waste materials

- Warning**   - Make sure to consult a waste treatment dealer for recommendations on the proper disposal of plastic valves. (Poisonous gas is generated when the valve is burned improperly.)

Sediment strainer (Type Y)

ASAHI YUKIZAI CORPORATION



Distributor

<http://www.asahi-yukizai.co.jp/en/>